

Honouring Craft.  
Delivering Excellence.



**GLYNGARY**

Product Guide



# Contents

---

Who we are	3
Our craft	5
Why timber	6
Our customers	9
Our 3 core principles	10
Our crafting techniques	11
Our materials	13

---

Signature range - Product matrix	15
Flush windows	17
Stormproof windows	21
Sash windows	25
Entrance doors	29
French doors	33
Sliding doors	35
Bi-folding doors	37

---

Colour	39
Hardware	41
Peace of mind guarantee	57
Tailored range	59
Help to sell and grow	61
Find out more	63





# Who we are

From our home in Cheshire, we've been proudly supplying hand-crafted wooden windows and doors to the trade since 1985. With decades of experience, our time served joiners craft each piece with passion and precision, knowing that our award-winning windows and doors are being installed in homes across Great Britain.

In recent years, we've seen a resurgence in the popularity of wooden windows and doors. More and more homeowners are recognising that timber is the superior choice for families who value sustainability, durability, energy efficiency, and long-lasting performance.

Scientific advances by the modified timber manufacturer Accoya have enhanced what can be achieved using timber. Accoya uses wood from fast-growing, FSC-certified forests, enhancing it through a unique acetylation process.

This process prevents the timber from absorbing water, dramatically improving its stability, durability, and energy efficiency—even in the face of Britain's ever-changing weather. Say goodbye to the warping, swelling, and distortion that often affects traditional timber products.

Not only does Accoya's timber offer superior performance, but it also stands as the most sustainable option on the market. Its wood comes from an infinite supply of responsibly managed forests, making it a far greener choice than hardwood, uPVC, or aluminium alternatives.

This is why we use Accoya as standard in our Signature range of hand-crafted windows and doors—because it offers the very best in sustainability, performance, and beauty.

# Honouring Craft.



# Delivering Excellence.



# Our craft



## You're in safe hands

We've been proudly supplying hand-crafted wooden windows and doors since 1985. It all started on this little saw, which we still hold in our workshop today as a reminder of where we came from.

We've come a long way, spending the last 40 years improving our joinery techniques, materials and machinery, whilst still honouring our traditions and craft.

This means after our products have been installed, homeowners can sit back and relax safe in the knowledge that their new windows and doors are the result of 40 years of hand-crafting excellence.

## Our beginnings

Glyngary was built on family values thorough the 80's, 90's and 00's by our founder, Colin Yates. He retired in 2017 and since then the business has been led by Colin's two sons Gary and Glyn, who have been involved in the family business since the 90's.

Today we operate from a 40,000 sq ft space in Cheshire. Our dedicated team includes time served joiners who've been part of our family for decades, as well as younger enthusiastic joiners who go through our testing apprenticeship scheme.



# Why timber

## Sustainability

Did you know that 43% of uPVC is derived from petroleum, a finite resource that contributes significantly to the world's carbon dioxide emissions?

In the face of a climate emergency, the need for sustainable, renewable, and fully recyclable building materials has never been more urgent.

By choosing windows and doors crafted from FSC-certified timber, you're supporting responsibly managed forests that maintain a constant, renewable cycle of supply. Trees naturally absorb around 25% of the carbon emissions produced by human activity.

However, as they age, their ability to capture carbon decreases, so at this point, they're transformed into Accoya, making room for new, fast-growing trees that can take up the carbon-absorbing role.

Accoya is not just an environmentally friendly choice—it's a groundbreaking one. Accredited by the FSC®, it's the only construction material worldwide to earn Cradle to Cradle (C2C) Platinum certification® for Material Health.

With its low carbon footprint, choosing Accoya windows and doors means your family is actively helping to reduce carbon emissions, contributing to a healthier planet.

We are committed to sustainability in every step of our process. In 2016, we invested in a biomass boiler heating system, which heats our workshop and paint drying booths using our own timber offcuts rather than gas. This is just one example of how we're reducing our environmental impact.

With a lifespan of over 70 years and fully recyclable at the end of their lifecycle, our hand-crafted windows and doors offer an unparalleled level of sustainability.

From the sourcing of materials to production and delivery, they are the ideal choice for families looking to make a positive difference in the face of today's environmental challenges.







## Durability

---

Our windows and doors offer outstanding resistance to insect attacks and damage. Thanks to Accoya's unique properties, it's indigestible to a wide range of pests, including termites, creating a natural, highly effective barrier against infestations.

Plus, Accoya's exceptional stability means there's minimal risk of issues during assembly, installation, or in the years to come.

Accoya sets a new standard for timber reliability. After undergoing the advanced acetylation process, it is rigorously checked and trusted not to swell, shrink, or distort. With only minimal movement, it remains highly durable, enduring the harshest climates for an impressive lifespan of 70+ years.

Our windows and doors are crafted to be structurally sound, using traditional joinery techniques honed over four decades. Combined with our dedication to sourcing only the finest materials, we create hand-finished products that are designed to perform seamlessly through both winter and summer, year after year.

## Energy efficiency

---

With rising costs and a growing energy crisis, energy efficiency has become a top priority for homeowners choosing new windows and doors.

Whilst uPVC and aluminium systems are constantly being modified and adapted just to meet the UK's increasingly stringent energy performance regulations, timber stands apart as a natural insulator, boasting low thermal transmittance and helping to retain warmth whilst keeping the cold out. By combining Accoya timber with high-performance, energy-efficient glass, our Signature range achieves industry-leading U-values.

Our double-glazed windows and doors deliver a U-value of 1.2 W/m<sup>2</sup>K, outperforming current UK regulations by 15%.

With triple glazing, the U-value can be as low as 0.68 W/m<sup>2</sup>k - an impressive 52% better than current standards. All our U-value testing and declarations adhere to BR442 guidelines and the EN 14351-1 standard, ensuring exceptional energy performance.

## Longevity

---

Hand-crafted wooden windows and doors are the result of skilled craftsmanship, not mass production. Each piece is meticulously created by professional, time-served joiners.

Every mortice and tenon joint, coat of paint, and decorative moulding requires time and expertise to perfect.

As a result, the initial cost of wooden windows and doors may be higher than uPVC or aluminium alternatives.

However, the true value of our windows and doors lies in their longevity.

With a life expectancy of over 70 years, they far outlast alternatives like uPVC, which typically last just 15-20 years.

Unlike uPVC or aluminium, which can start to look worn out over time with no easy way to refresh them, our timber windows and doors can be repainted to look like new. As trends evolve, children grow up, and homes are redecorated, your windows and doors can evolve with you.

Repainting not only restores your windows and doors to their original beauty but also allows them to blend seamlessly with new decor styles.

From the moment they're installed, our Accoya high-performance windows and doors start paying for themselves—delivering long-lasting value, timeless appeal, and unmatched durability.





# Our customers

## Window installers

We help large and small window installation businesses across the UK to capitalise on the timber comeback.

Our Signature product range has been designed to make our beautiful hand-crafted products easy to understand, and we've built a catalogue of physical and digital sales tools that help installers to sell and grow.

Installers who fit our beautiful products stand-out from their local competitors, by offering materials that outperform and look better than uPVC and aluminium alternatives.

## Builders, contractors and developers

We help house builders, contractors and developers to build beautiful homes, or re-develop traditional properties with a deserved nod to their original heritage.

Our team of experts can guide our trade customers seamlessly through the whole process, ensuring a beautiful project delivered smoothly, and on time.

Our Tailored product range allows us to cater for the exact shapes, sizes and specifications needed to fulfil whatever the project requires, however weird and wonderful those specifications may be.

## Builders' merchants, online distributors and trade counters

We help builders' merchants, online distributors and trade counters seamlessly supply our hand-crafted products to their onwards trade customers.

A plethora of sales tools combined with great service and direct-to-site deliveries guarantee an effortless process that is exciting for any driven branch manager.

We understand this market thoroughly, and our distributor pricing level allows re-sellers to make an attractive margin on our 'easy-to-understand and sell' Signature product range.

## When it comes to trade supply, 3 principles are engrained into our core.

### 1. Make the best hand-crafted windows and doors

Since 1985, we've been hand-crafting windows and doors with passion, precision and love, right here in the UK. Every seamless joint is made with the utmost care, and we dedicate time to ensuring each product is flawless before it leaves our workshop.

We source only the finest materials from trusted suppliers, which is why our windows and doors offer industry-leading thermal efficiency, with U-values as low as 0.68 W/m<sup>2</sup>K. With guarantees of up to 25 years and four decades of expertise behind us, we confidently stand by the quality of our products, offering a promise of excellence to all our trade customers.

### 2. Help our customers to sell and grow

We're dedicated to helping our trade customers win more business in an increasingly competitive market. That's why we've developed a suite of physical and digital sales tools designed to make it easier for our customers to close more deals.

Our products are straightforward, and we back them up with personalised service and technical support on every order, no matter the size. Our strict trade-only policy ensures that we never compete with our customers. When we generate homeowner leads, we pass them directly to our approved local installers. We're here to support your business, not compete.

### 3. Care for our planet

Caring for the environment is at the core of everything we do. That's why we hand-craft our windows and doors using fast-growing, sustainably sourced modified timber.

We carefully choose our raw materials and suppliers, and our factory is powered by timber offcuts, minimising waste. Every decision we make is guided by our commitment to the wellbeing of the planet.





# Our crafting techniques

## Seamless corners

Mass-produced timber manufacturers that focus on speed can often be identified by their use of shadow grooves on the frame and sash corner joints. Shadow grooves are used regularly because they hide corners that are not perfectly flush fitting. Decades of bench joinery experience enables us to achieve mortice and tenon corner joints that are seamless, flush and almost invisible. We finish them flush because we proudly enjoy having nowhere to hide. Our corners are perfect every time.



## Flush-fit, colour matched trickle vents

Trickle vents are ugly, but ours are made from aluminium, not plastic. They boast a flush finish inside and out, with the outside grille being virtually hidden by our head drip when fitted in the outer frame. We paint our vents, so they are an identical match to the colour of the frame.

\*Flush vent externally is only available in outer frame and head drip must be fitted.



## Shootbolt and egress, as standard

We fit shootbolt locking as standard, and egress escape hinges on all side openers as standard. As well as effortlessly complying with fire escape regulations if sash widths allow, egress hinges provide a traditional timber look, with the sash swinging open from the corner. Butt hinges with peg stays are also available.



## Sash windows with options

We proudly offer 4 sash horn designs, as well as 4 staff bead options, 4 outside lining options and 3 external glazing bead options. This allows our sash windows to fit in with any type of property. Our sash horns are hand finished using our precision bandsaw and oscillating spindle sander.

In addition, we can offer any bespoke shape of sash horn to match existing windows as part of our Tailored range, from a template or detailed drawing.



## Three-coat, dual colour paint

We apply a three-coat professional spray finish to all our windows and doors, ensuring a perfectly consistent finish every time. Each coat contains 120-150 microns of paint, which is the equivalent of 10 brush coats. We can match any RAL or Farrow & Ball colour, and we can dual colour, giving a different appearance to the inside and outside of the home.



## Externally beaded, glass sealed

Our windows and doors are externally beaded, which gives them the traditional look they deserve. Our glass is security taped in place meaning it cannot be removed from the outside by unwanted intruders. External beading not only looks better, but it also eliminates the risk of water building up in the rebate channel, which can inevitably work its way through an internal bead into the home causing damage to internal surfaces.



## Twin mortice and tenon sash joint

Over four decades we've perfected our corner joints. On window sashes we take extra time to craft twin mortice and tenon joints, as standard, combined with star dowel fixing.

This traditional method ensures every corner leaves our workshop strong, secure, and ready to last for a lifetime of operation.





# Our materials

## Timber

We use Accoya as standard on our Signature range of windows and doors because we believe it's the best material available.

If requested, as part of our Tailored range we can also create windows and doors in a range of hardwood options.



GUARANTEE

## Hardware

We are proud to offer two premium hardware ranges from UK based suppliers 'Coastal Group' based in Cornwall and 'From the Anvil' based in Llandrindod Wells, Wales.

Using two ranges allows us to cover all hardware styles from modern to traditional. All our hardware is premium grade and boasts a 10-year guarantee.



GUARANTEE



## Glass

Our energy performance glass comes from the UK's premium glass manufacturer System 3, who are based locally in Manchester.

System 3 are well known for the quality of their glass, so we wouldn't trust anyone else's product in our windows.



GUARANTEE

## Paint

Our paint comes from leading supplier Teknos, who have been producing in Finland since 1948. Teknos have been working in collaboration with Accoya since 2008, ensuring a perfect combination for a long-lasting finish. All our windows and doors are triple coated in our dedicated paint shop before leaving our workshop.



GUARANTEE





## Flush window

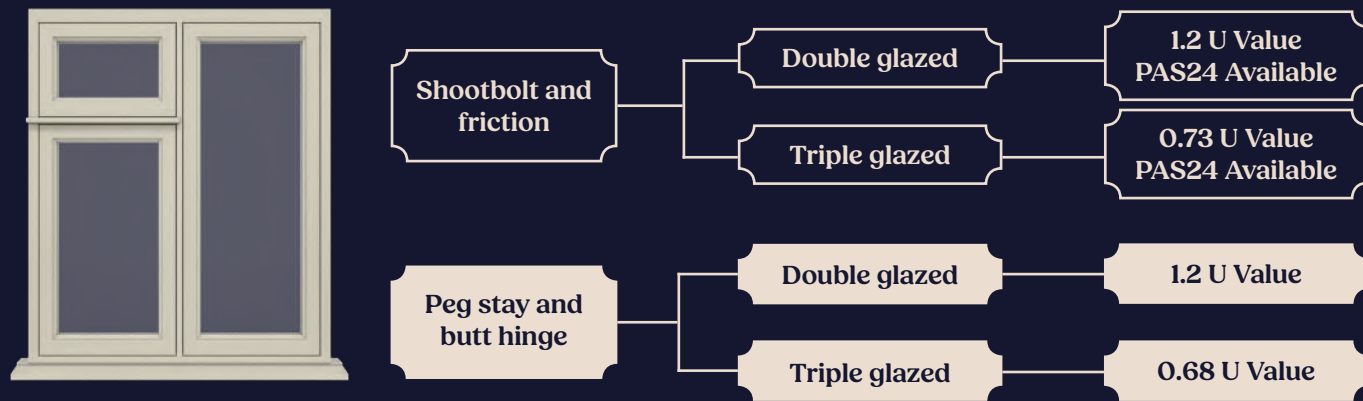

## Stormproof window

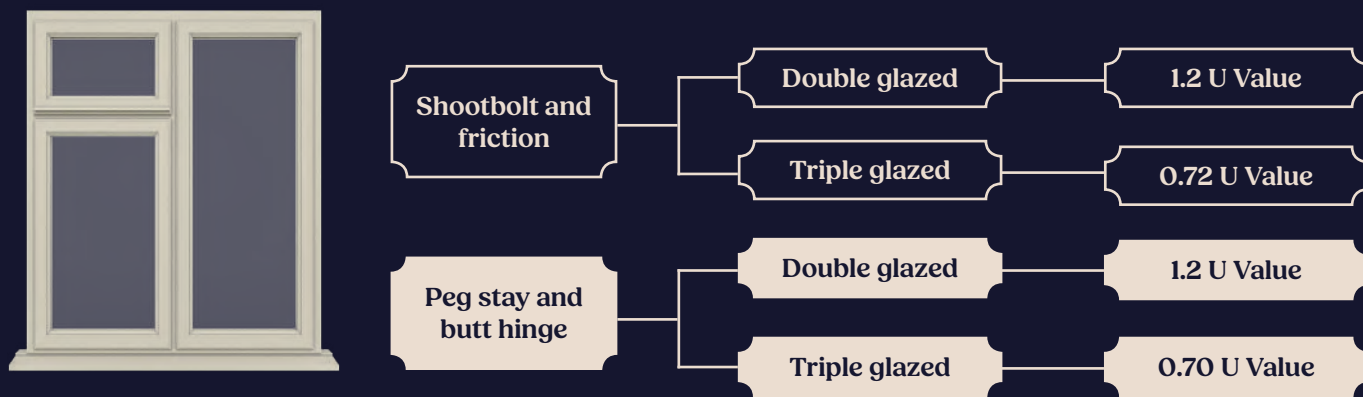

## Sash window

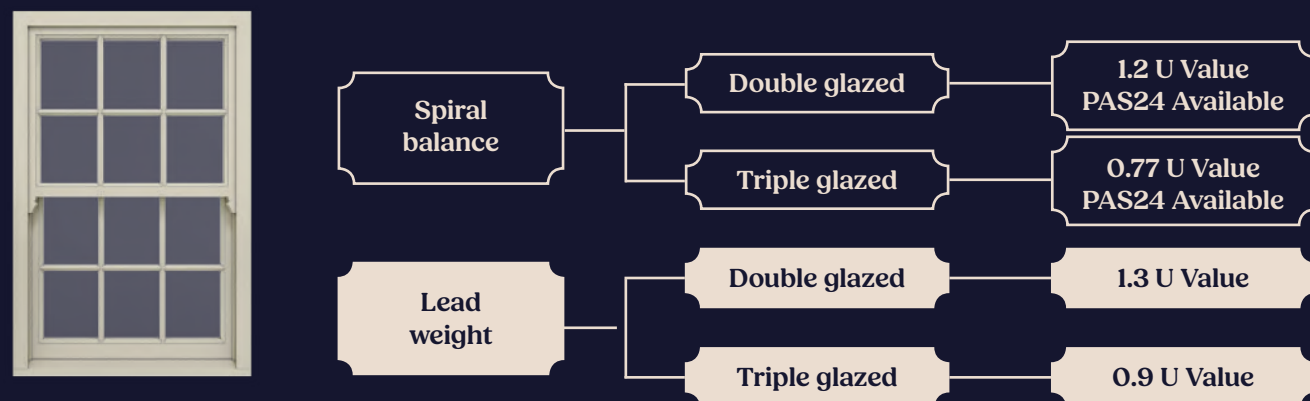

## Entrance door



## French door



## Sliding door



## Bi-fold door

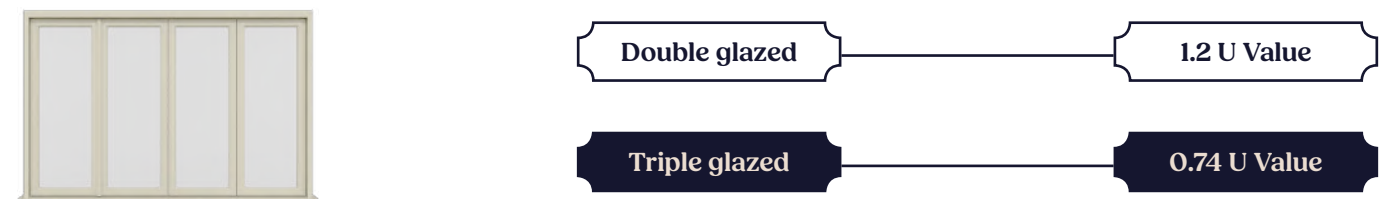



# Flush window

Shootbolt and friction hinge

**1.2**  
W/km<sup>2</sup>K

Double Glazed  
U-Value

**0.73**  
W/km<sup>2</sup>K

Triple Glazed  
U-Value

**PAS24**

Available

## About:

Our flush windows are hand crafted to perfection, offering a traditional look outside the property with the window sash finishing flush with the frame. This version comes with Yale shootbolt locking and friction hinges, meaning PAS24 can be achieved. Available with both double and triple glazing.



## Feature:

- Seamless corner joints, using twin mortice and tenon joints on all sash corners
- Flush-fit colour matching trickle vents, made from aluminium
- Three coat factory paint finish, dual colour available
- Externally beaded for tradition, taped glass for high security
- Range of cill sizes available
- Available with a large outerframe (20mm bigger) or a 20mm add on supplied separately
- Head drips sent with all frames
- Crafted by experts
- 70+ year life expectancy

## Specification:

- Yale multi point shootbolt lock with night vent position
- Choice of 7 shootbolt window handle styles, from 2 suppliers, in multiple finishes
- High security friction hinges, egress as standard on all side openers
- 1.2 whole window U value with double glazing
- 0.73 whole window U value with triple glazing
- PAS24 available

## Double glazed

### Cill:

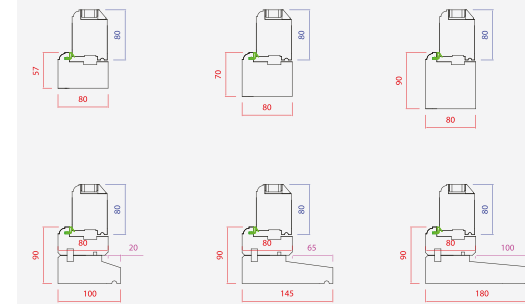

### Trickle vent:

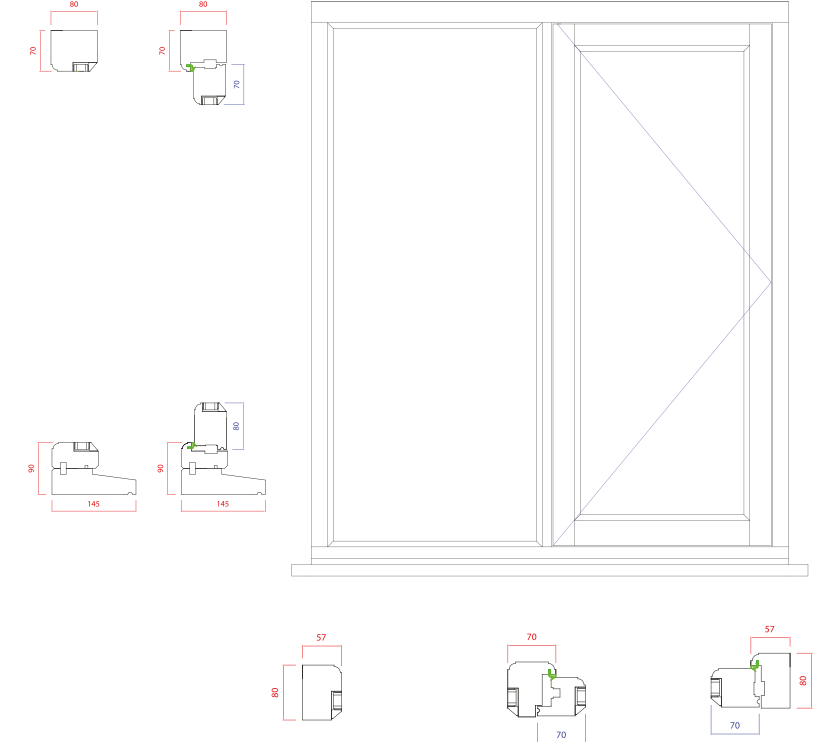
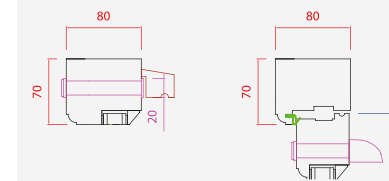

## Triple glazed

### Cill:

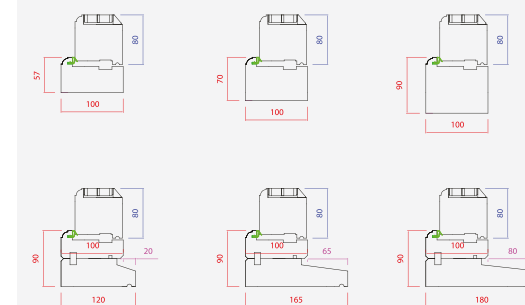

### Trickle vent:

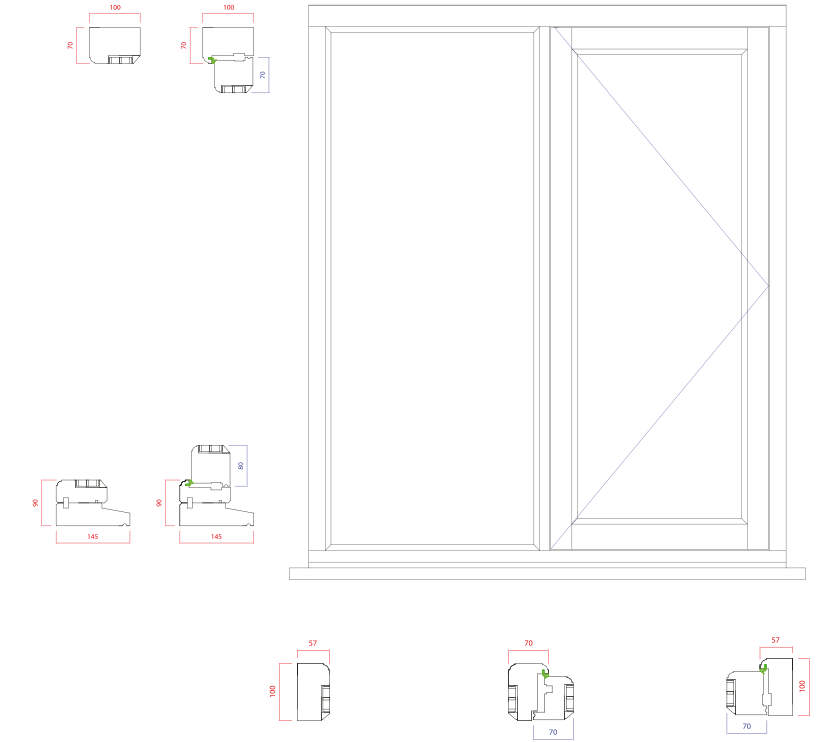
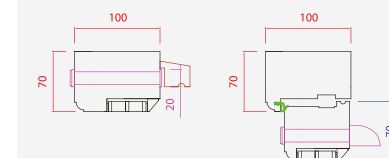



# Flush window

Peg stay and butt hinge

**1.2**  
W/km<sup>2</sup>K

Double Glazed  
U-Value

**0.68**  
W/km<sup>2</sup>K

Triple Glazed  
U-Value

## About:

Our flush windows are hand crafted to perfection, offering a traditional look outside the property with the window sash finishing flush with the frame.

This version comes with a peg stay and butt hinge hardware option, for a traditional look. Available with both double and triple glazing.



## Feature:

- Seamless corner joints, using twin mortice and tenon joints on all sash corners
- Flush-fit colour matching trickle vents, made from aluminium
- Three coat factory paint finish, dual colour available
- Externally beaded for tradition, taped glass for high security
- Range of cill sizes available
- Available with a large outerframe (20mm bigger) or a 20mm add on supplied separately
- Head drips sent with all frames
- Crafted by experts
- 70+ year life expectancy

## Specification:

- Traditional looking peg-stay, fastener and hinge
- Choice of 4 hardware styles, from 2 suppliers, in multiple finishes
- 1.2 whole window U value with double glazing
- 0.68 whole window U value with triple glazing

## Double glazed

### Cill:

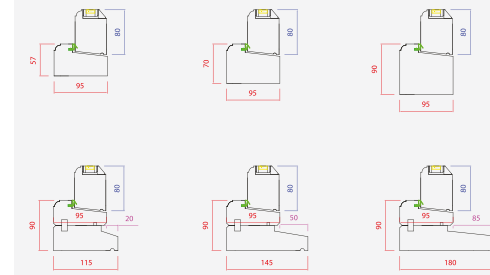

### Trickle vent:

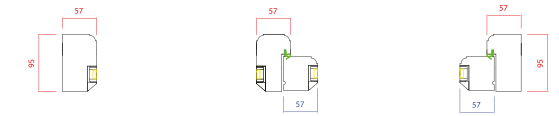
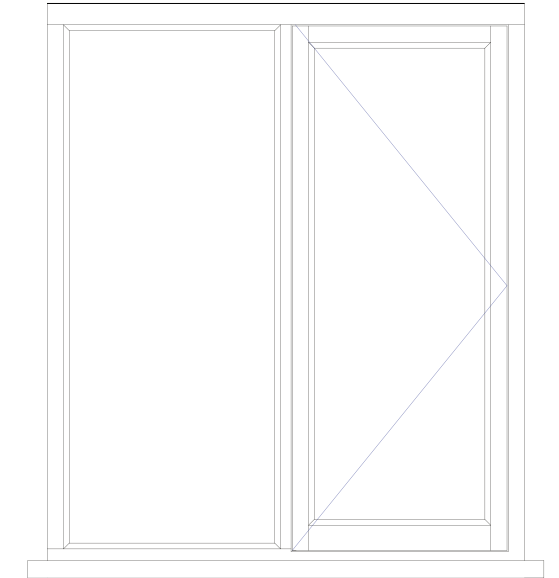
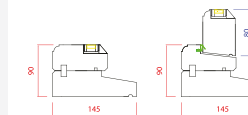
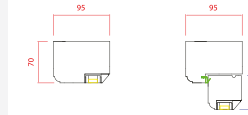
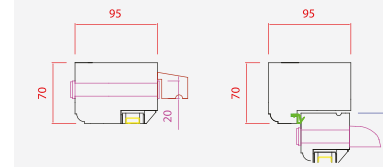

## Triple glazed

### Cill:

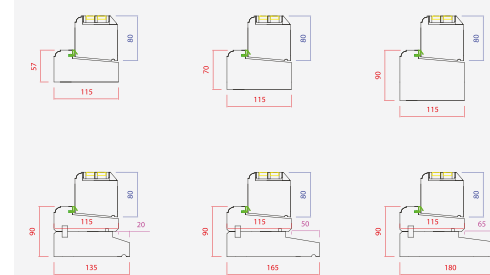

### Trickle vent:

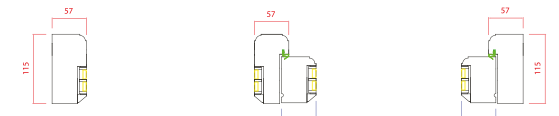
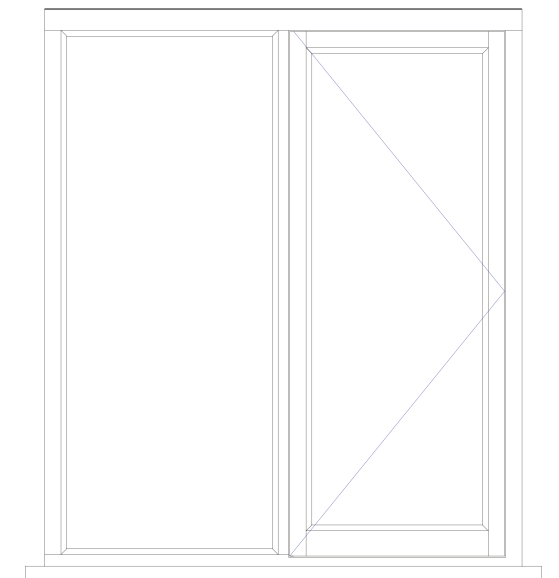
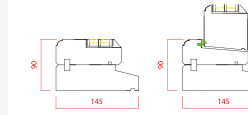
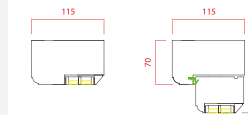
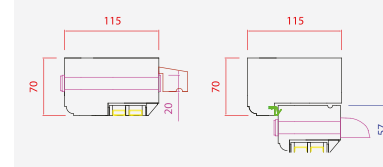



# Stormproof window

Shootbolt and friction hinge

**1.2**  
W/km<sup>2</sup>K

Double Glazed  
U-Value

**0.72**  
W/km<sup>2</sup>K

Triple Glazed  
U-Value

## About:

Our stormproof windows are hand crafted to perfection, offering double rebated protection against the outside elements. This version comes with Yale shootbolt locking and friction hinges. Available with both double and triple glazing.



## Feature:

- Seamless corner joints, using twin mortice and tenon joints on all sash corners
- Flush-fit colour matching trickle vents, made from aluminium
- Three coat factory paint finish, dual colour available
- Externally beaded for tradition, taped glass for high security
- Range of cill sizes available
- Available with a large outerframe (20mm bigger) or a 20mm add on supplied separately
- Head drips sent with all frames
- Crafted by experts
- 70+ year life expectancy

## Specification:

- Yale multi point shootbolt lock with night vent position
- Choice of 7 shootbolt window handle styles, from 2 suppliers, in multiple finishes
- High security friction hinges, egress as standard on all side openers
- 1.2 whole window U value with double glazing
- 0.72 whole window U value with triple glazing

## Double glazed

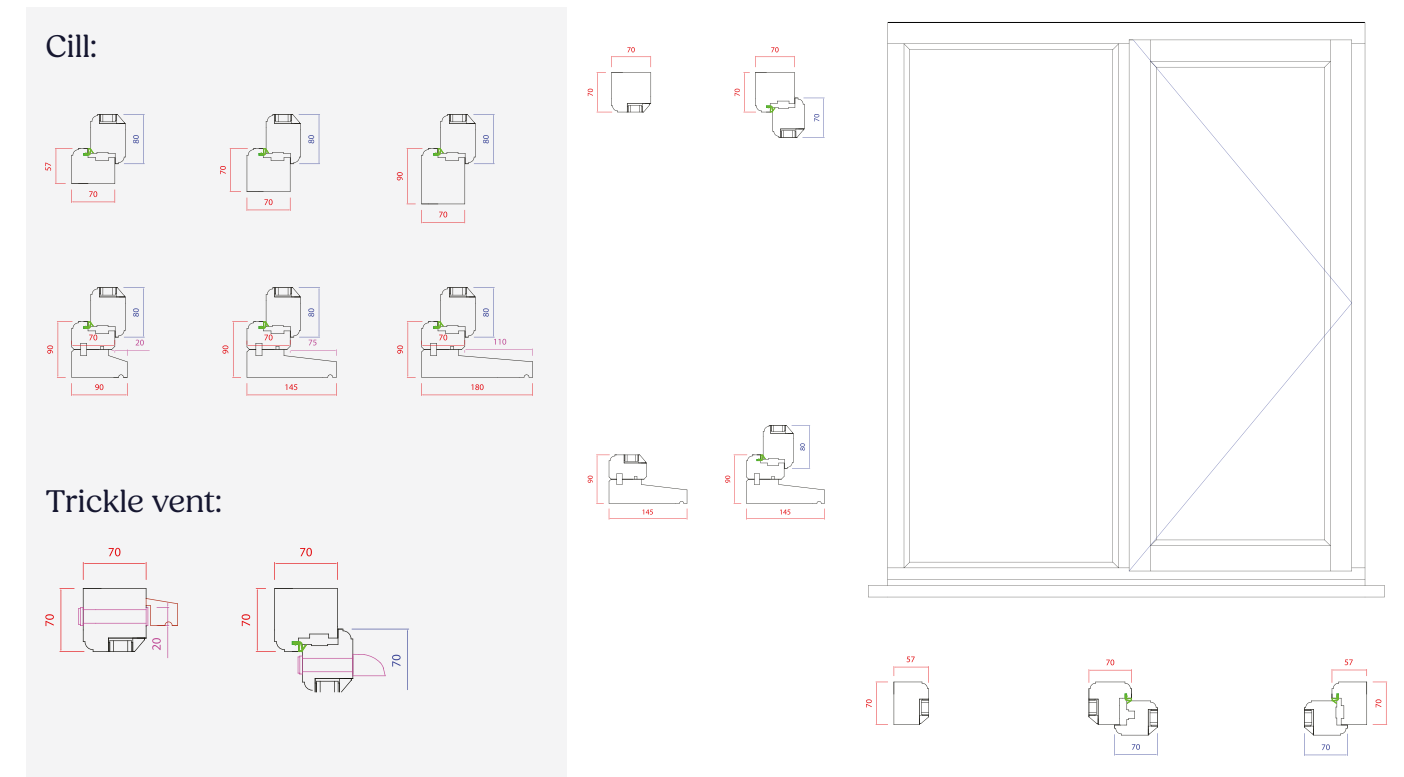

## Triple glazed

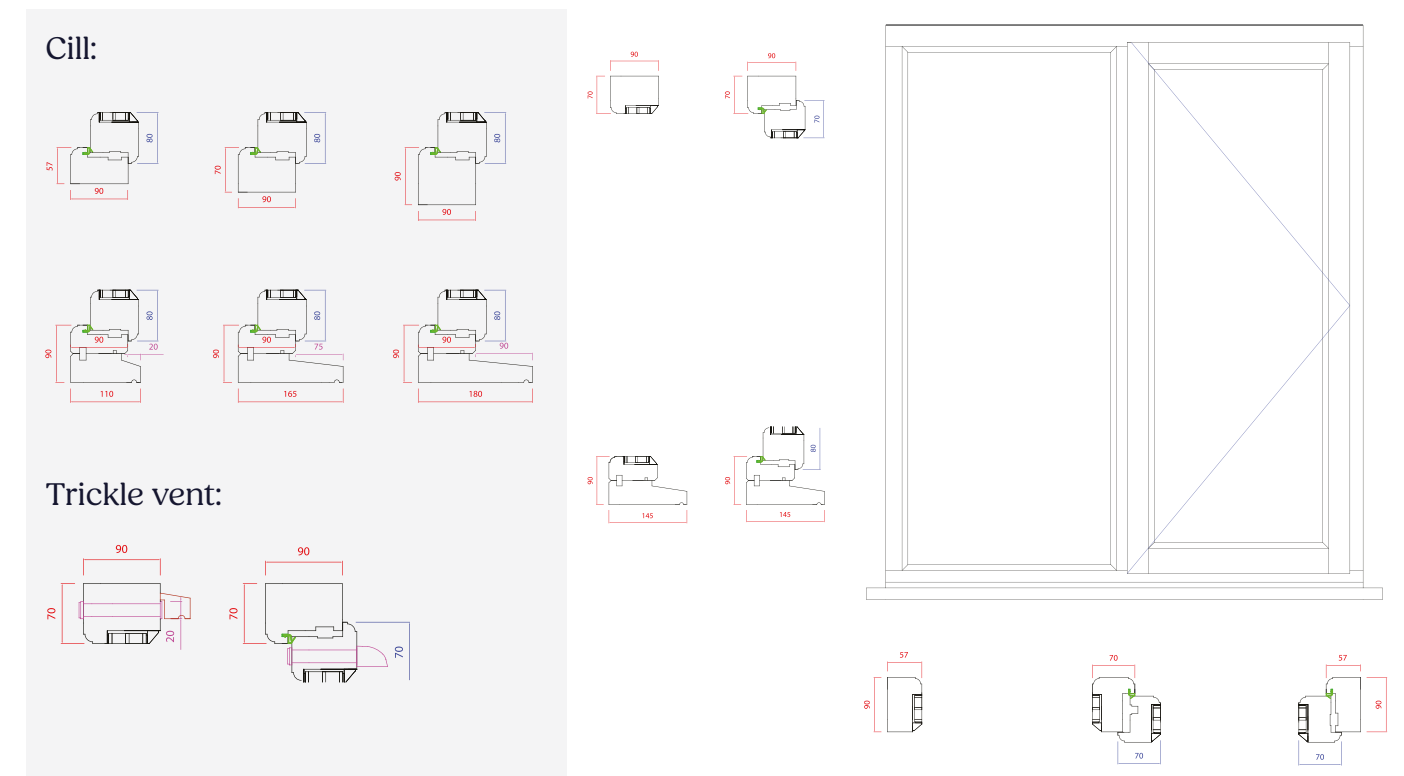



# Stormproof window

Peg stay and butt hinge

**1.2**  
W/km<sup>2</sup>K

Double Glazed  
U-Value

**0.70**  
W/km<sup>2</sup>K

Triple Glazed  
U-Value

## About:

Our stormproof windows are hand crafted to perfection, offering double rebated protection against the outside elements.

This version comes with peg-stays, fasteners and stormproof butt hinges to maintain a more traditional look and feel. Available with both double and triple glazing.



## Feature:

- Seamless corner joints, using twin mortice and tenon joints on all sash corners
- Flush-fit colour matching trickle vents, made from aluminium
- Three coat factory paint finish, dual colour available
- Externally beaded for tradition, taped glass for high security
- Range of cill sizes available
- Available with a large outerframe (20mm bigger) or a 20mm add on supplied separately
- Head drips sent with all frames
- Crafted by experts
- 70+ year life expectancy

## Specification:

- Traditional looking peg-stay, fastener and hinge
- Choice of 4 hardware styles, from 2 suppliers, in multiple finishes
- 1.2 whole window U value with double glazing
- 0.70 whole window U value with triple glazing

## Double glazed

### Cill:

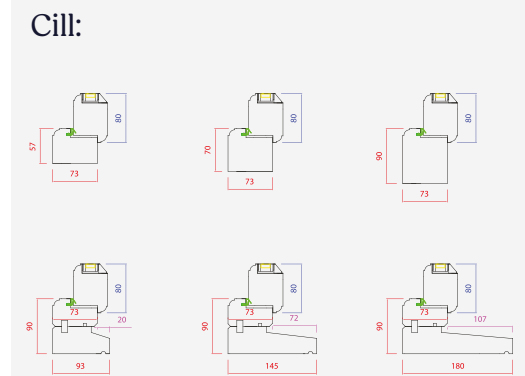

### Trickle vent:

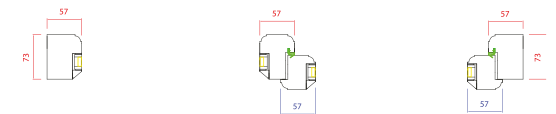
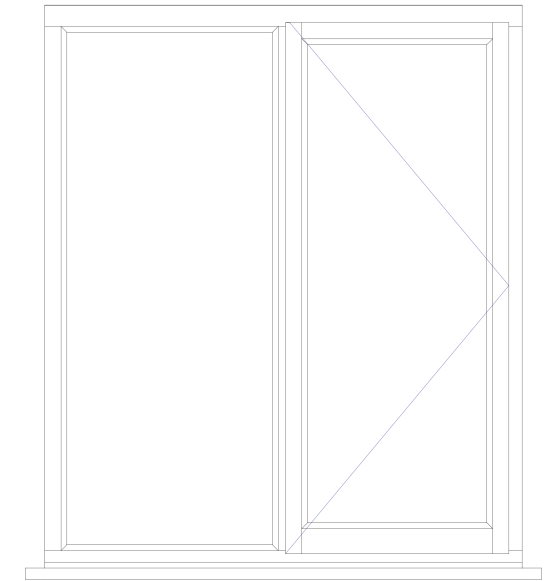
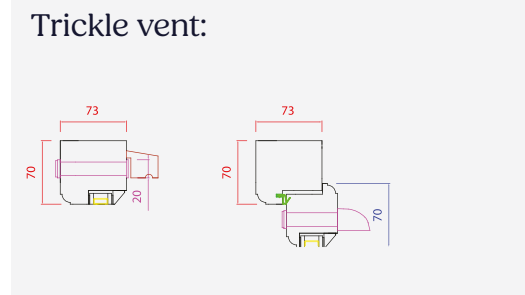

## Triple glazed

### Cill:

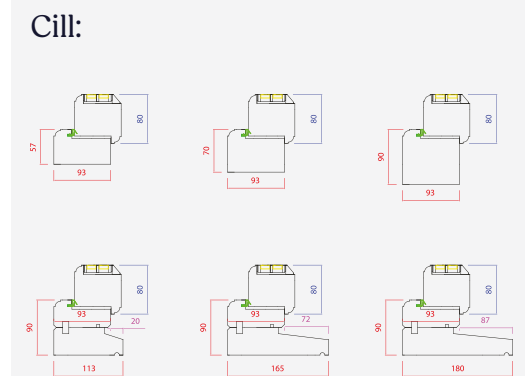

### Trickle vent:

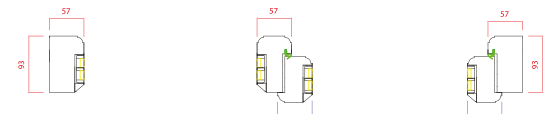
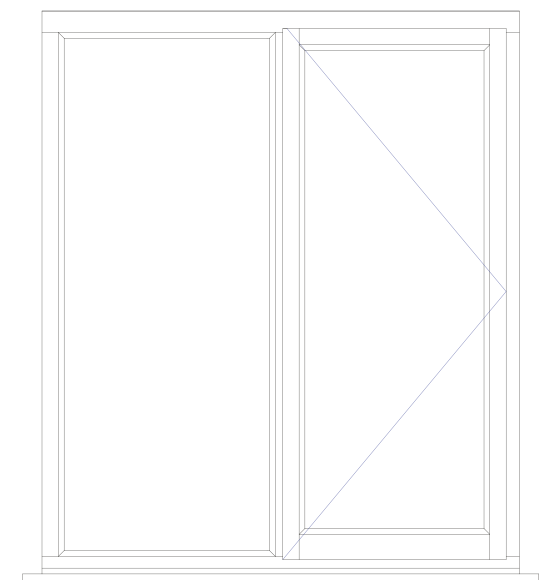
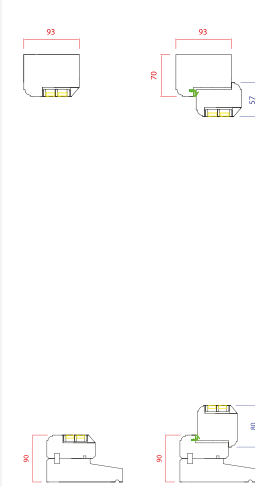
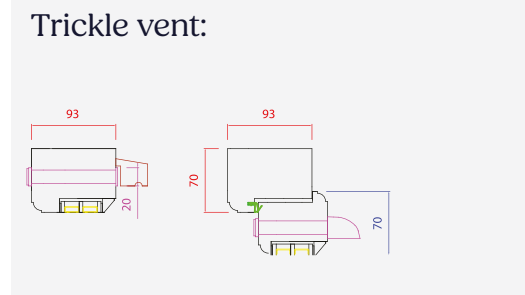



# Sash window

Spiral balance

**1.2**  
W/km<sup>2</sup>K

Double Glazed  
U-Value

**0.77**  
W/km<sup>2</sup>K

Triple Glazed  
U-Value

**PAS24**

Available

## About:

Our sash windows are hand crafted to perfection, boasting classic sash aesthetics with smooth long lasting operation. This option with spiral balance sliding which can be PAS24 compliant.

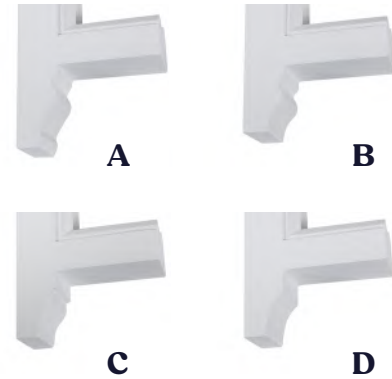

## Feature:

- Seamless corner joints, using twin mortice and tenon joints on all sash corners
- Flush-fit colour matching trickle vents, made from aluminium
- Three coat factory paint finish, dual colour available
- Externally beaded for tradition, taped glass for high security
- Available with a large outerframe (20mm bigger) or a 20mm add on supplied separately
- Crafted by experts
- 70+ year life expectancy

## Specification:

- Choice of hardware and finish options from leading ironmongers Coastal Group
- 1.2 whole window U value with double glazing
- 0.77 whole window U value with triple glazing
- PAS24 available
- Choice of 4 internal staff bead and external lining options

## Double glazed

### Cill:

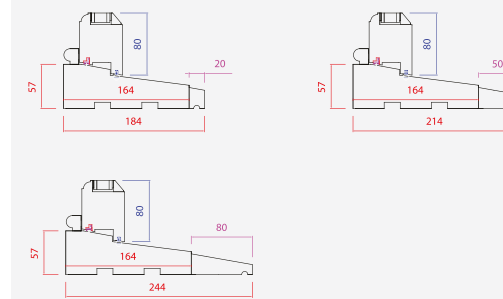

### Trickle vent:

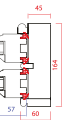
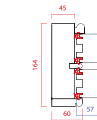
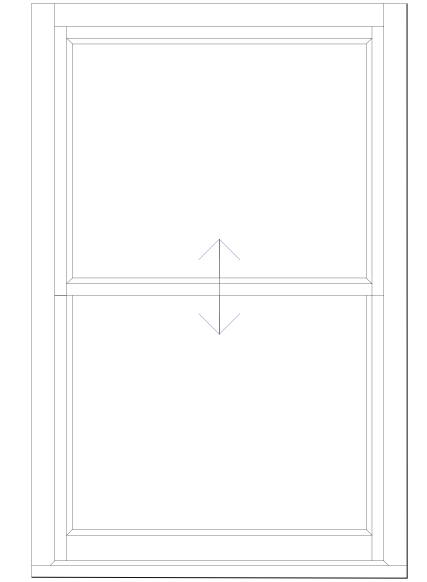
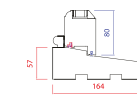
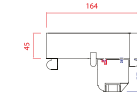
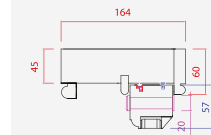

## Triple glazed

### Cill:

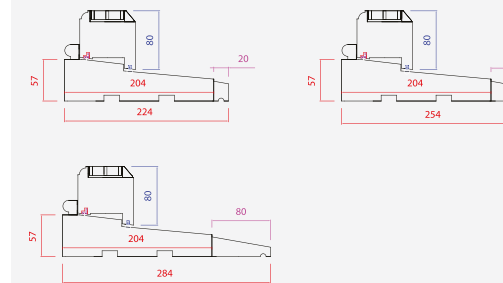

### Trickle vent:

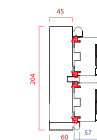
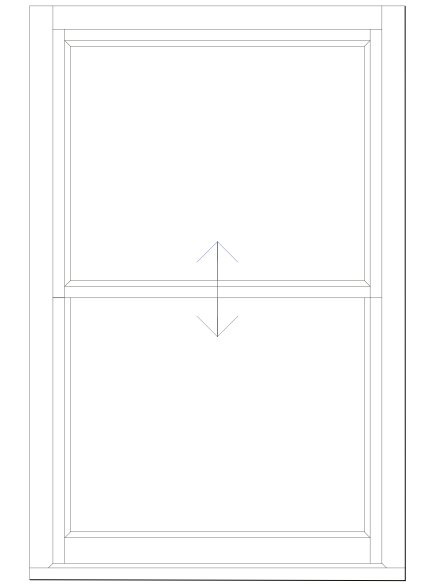
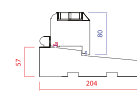
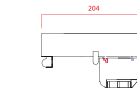
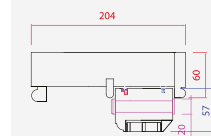



# Sash window

Lead weight

**1.3**

W/km<sup>2</sup>K

Double Glazed  
U-Value

**0.90**

W/km<sup>2</sup>K

Triple Glazed  
U-Value

## About:

Our sash windows are hand crafted to perfection, boasting classic sash aesthetics with smooth long-lasting operation.

Lead weight sash windows allow the sash to slide smoothly and freely up and down. The sash weight is matched to the lead weights, attached with a sash cord over an axel pully wheel, resulting in a completely frictionless motion of travel.



## Feature:

- Seamless corner joints, using twin mortice and tenon joints on all sash corners
- Flush-fit colour matching trickle vents, made from aluminium
- Three coat factory paint finish, dual colour available
- Externally beaded for tradition, taped glass for high security
- Available with a large outerframe (20mm bigger) or a 20mm add on supplied separately
- Crafted by experts
- 70+ year life expectancy

## Specification:

- Choice of hardware and finish options from leading ironmongers Coastal Group
- The ultimate in honouring traditional methods
- Frictionless motion of travel, up and down
- 1.3 whole window U value with double glazing
- 0.9 whole window U value with triple glazing
- Choice of 4 internal staff bead and external lining options

## Double glazed

### Cill:

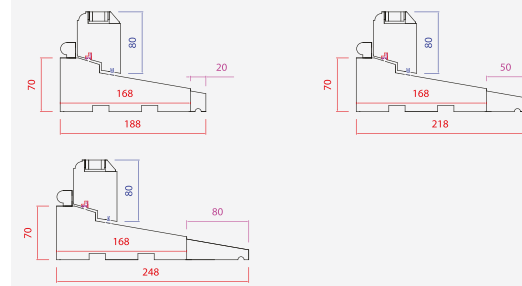

### Trickle vent:

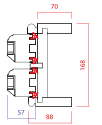
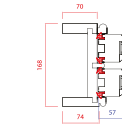
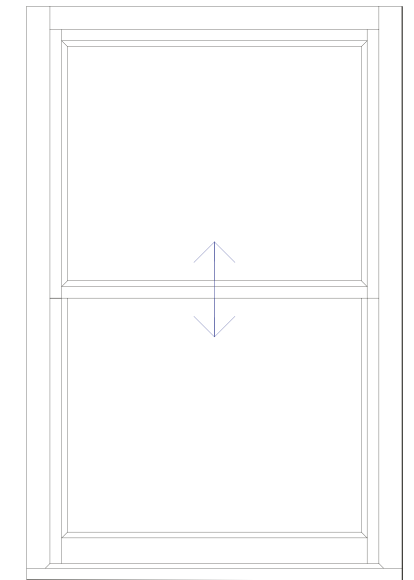
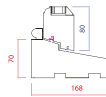
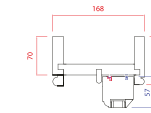
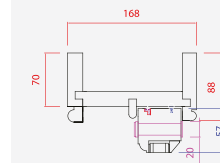

## Triple glazed

### Cill:

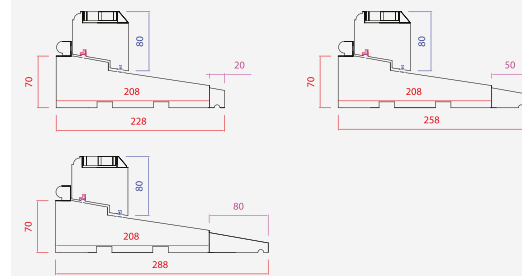

### Trickle vent:

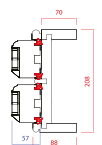
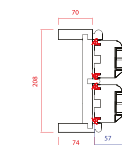
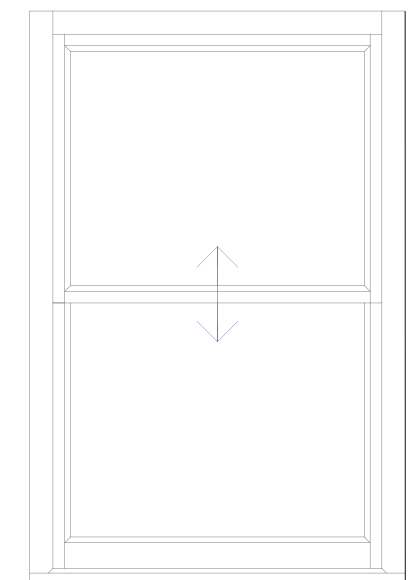
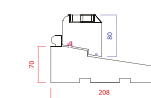
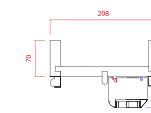
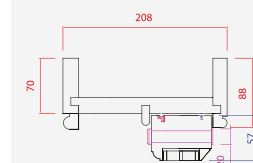



# Entrance door

**1.2**  
W/km²K

Double Glazed  
U-Value

**0.71**  
W/km²K

Triple Glazed  
U-Value

**PAS24**

Available



## About:

Our high security entrance doors are available in a range of styles, catering for traditional and modern needs. We offer a range of glass options to compliment each design. Using Maco multipoint door locks, Ultion 3\* door cylinders and solid Accoya, our entrance doors are not only beautiful, but also safe and secure from unwanted intruders.



## Feature:

- Seamless corner joints, using twin mortice and tenon joints on all sash corners
- Flush-fit colour matching trickle vents, made from aluminium
- Three coat factory paint finish, dual colour available
- Vertically factory hung, ensuring perfect positioning and squareness
- Externally beaded for tradition, taped glass for high security
- Available with a large outerframe (20mm bigger) or a 20mm add on supplied separately
- Available with a stable door opening mechanism
- Crafted by experts
- 70+ year life expectancy

## Specification:

- Exitex low threshold for easy access, available in 3 finishes
- Maco high security multi-point door lock
- Ultion 3\* high security cylinders as standard
- Made from solid Accoya, reliably trusted to not visibly swell, shrink or distort
- Highly decorative details, such as bolection mouldings and R&F panels - style that cannot be matched by uPVC or GRP Composite doors
- Choice of 7 hardware styles, from 2 suppliers, in multiple finishes
- 1.2 whole door U value with double glazing
- 0.71 whole door U value with triple glazing
- PAS24 available

## Double glazed

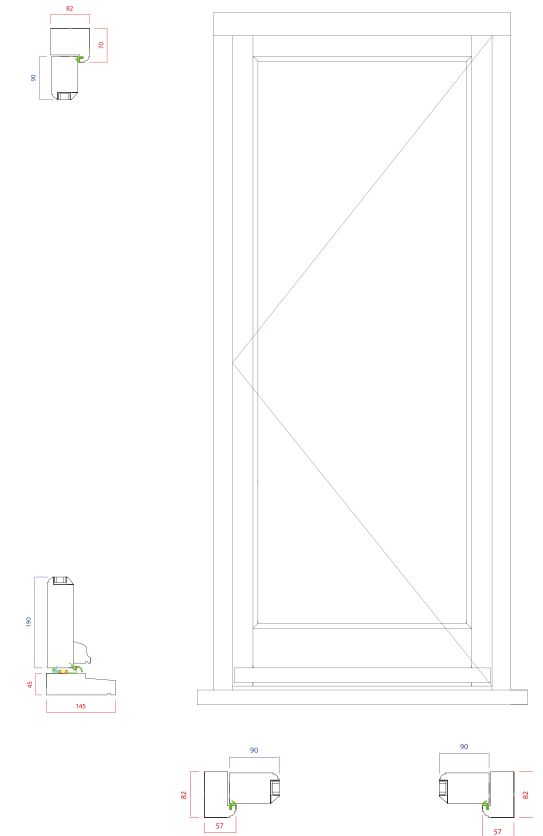
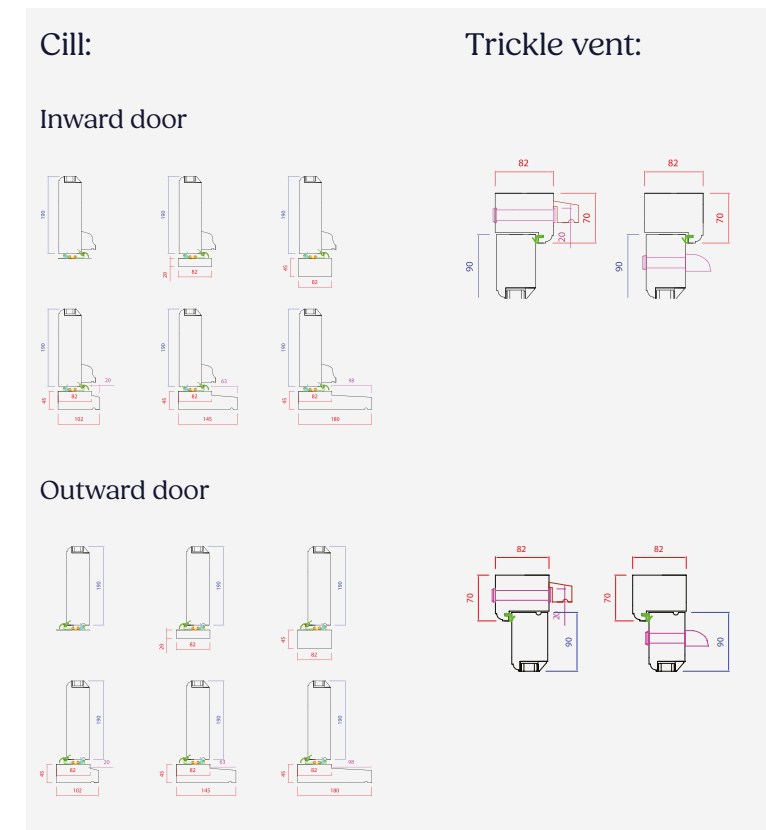

## Triple glazed

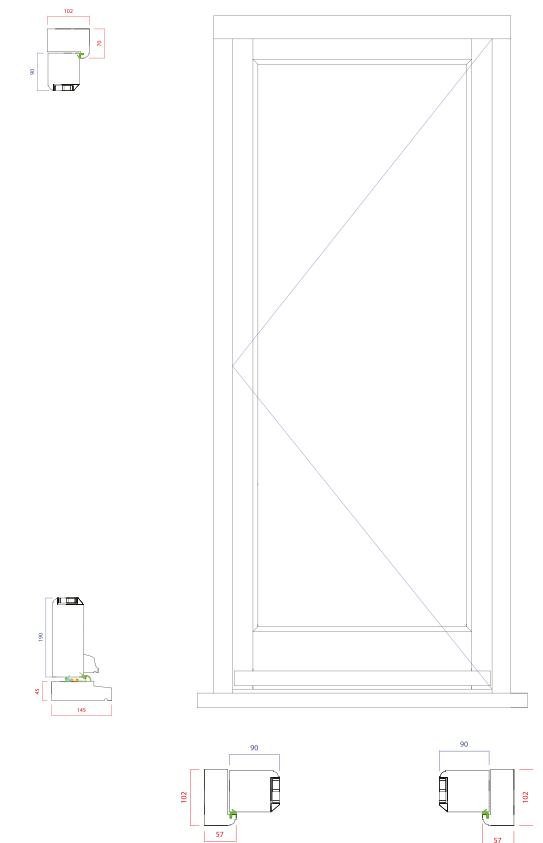
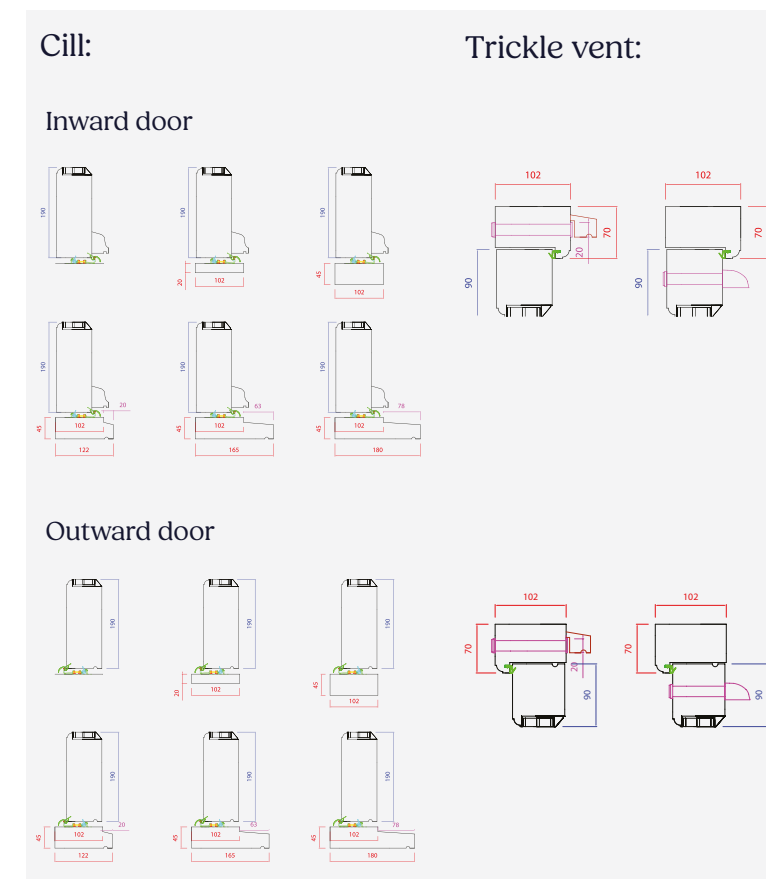





**Our  
entrance  
door styles**

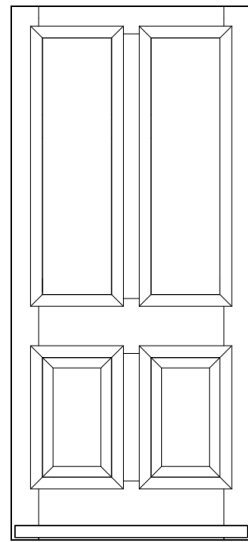

**Didsbury**

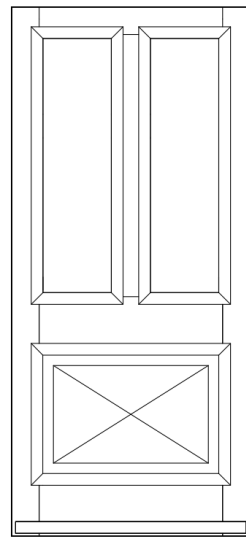

**Knutsford**

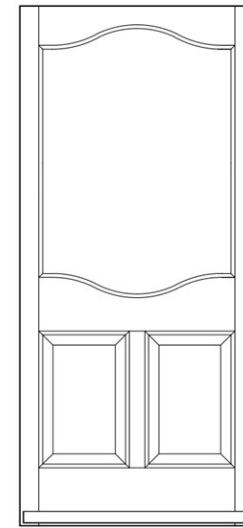

**Cartmel**

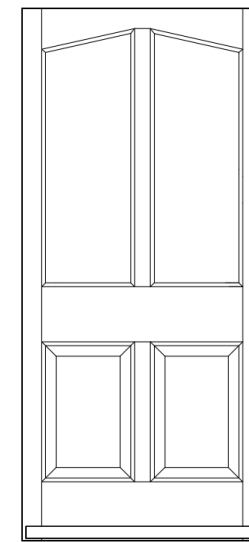

**Ashley**

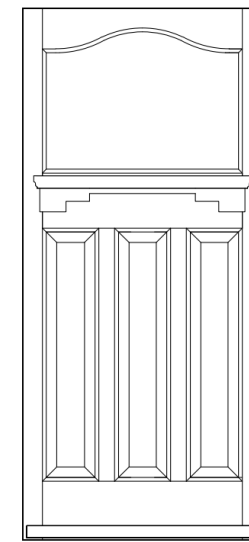

**Marple**

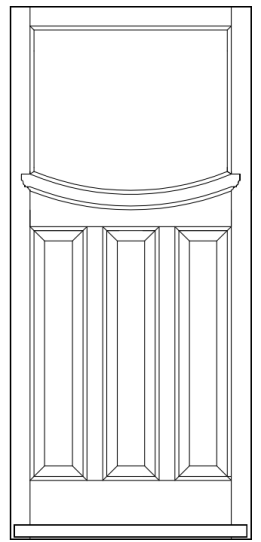

**Heaton**

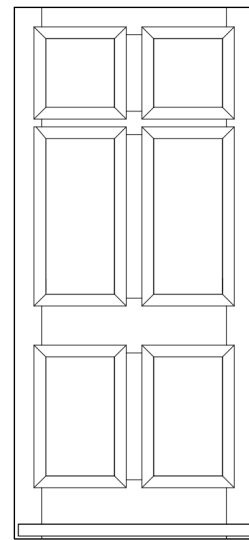

**Bowden**

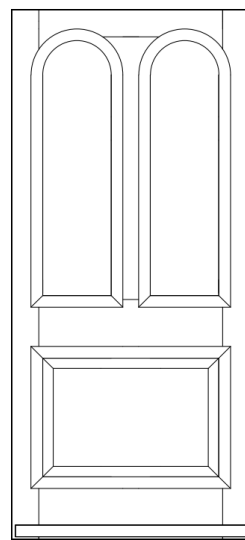

**Wilmslow**

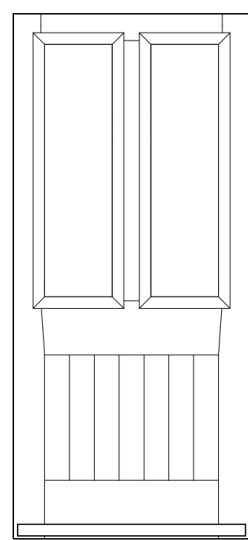

**Bramhall**

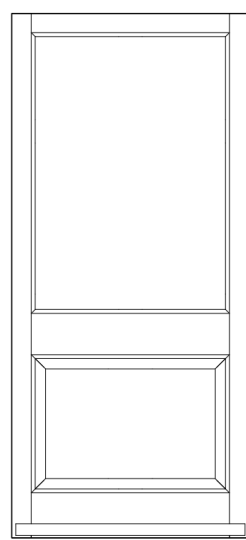

**Prestwich**

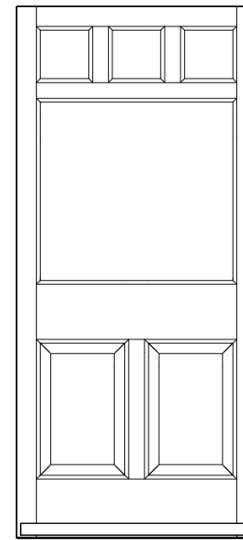

**Alderly**

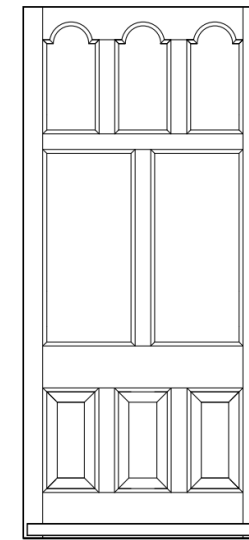

**Hale**

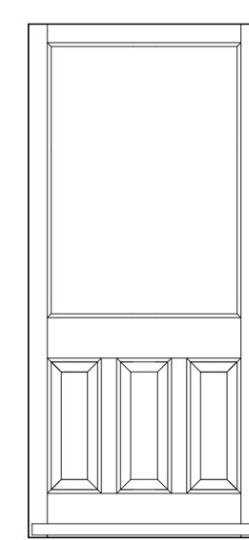

**York**

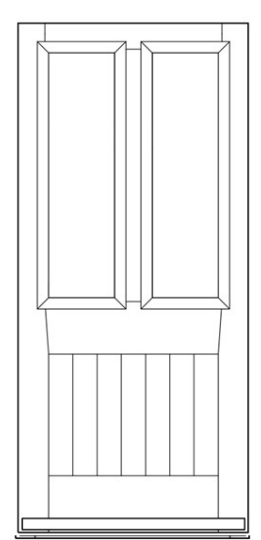

**Harrogate**

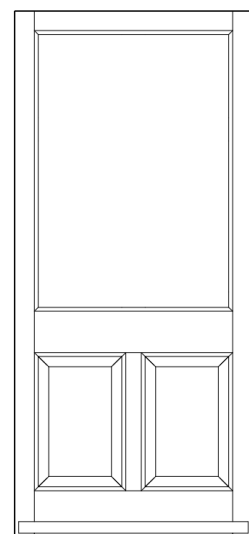

**Tatton**

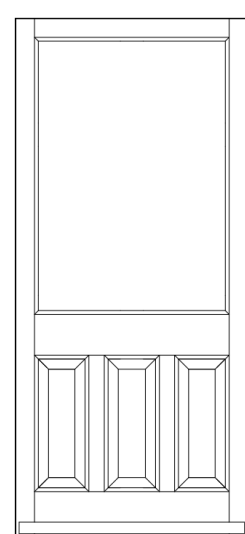

**Mere**

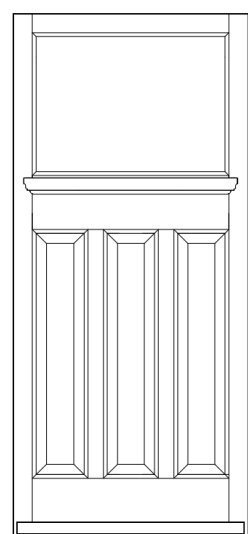

**Eaton**

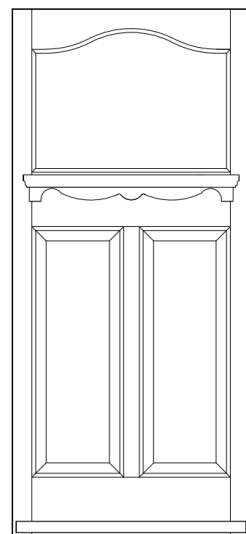

**Downham**

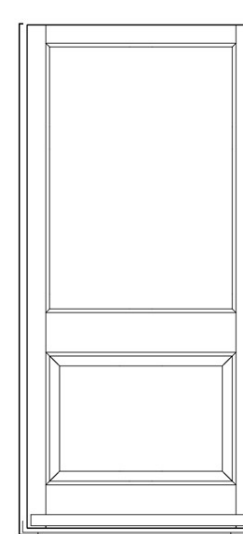

**Bollington**

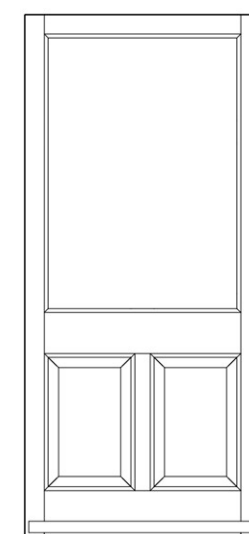

**Elworth**

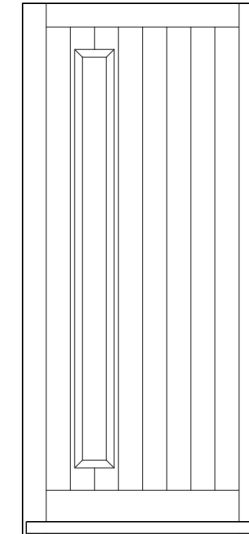

**Chester**

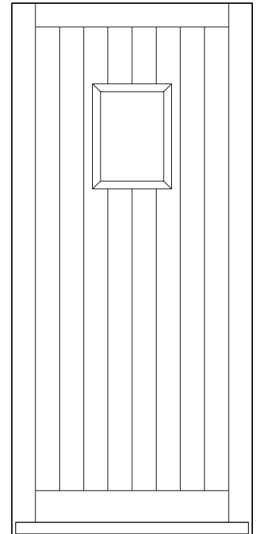

**Whitby**



# French door

**1.2**  
W/km<sup>2</sup>K

Double Glazed  
U-Value

**0.73**  
W/km<sup>2</sup>K

Triple Glazed  
U-Value

**PAS24**

Available



## About:

Our high security French doors are available opening inwards or outwards, fitted with 2 fully functional multi point door locks and lever/lever handles. Using Maco multipoint door locks, Ultion 3\* door cylinders and solid Accoya, our French doors are not only beautiful, but also safe and secure from unwanted intruders.



## Feature:

- Seamless corner joints, using twin mortice and tenon joints on all sash corners
- Flush-fit colour matching trickle vents, made from aluminium
- Three coat factory paint finish, dual colour available
- Vertically factory hung, ensuring perfect positioning and squareness
- Externally beaded for tradition, taped glass for high security
- Available with a large outerframe (20mm bigger) or a 20mm add on supplied separately
- Available in a range of styles
- Crafted by experts
- 70+ year life expectancy

## Specification:

- Exitex low threshold for easy access, available in 3 finishes
- Maco high security multi-point door lock
- Ultion 3\* high security cylinders as standard
- Made from solid Accoya, reliably trusted to not visibly swell, shrink or distort
- Choice of 7 hardware styles, from 2 suppliers, in multiple finishes
- 1.2 whole door U value with double glazing
- 0.73 whole door U value with triple glazing
- PAS24 available

## Double glazed

### Cill:

### Trickle vent:

#### Inward door

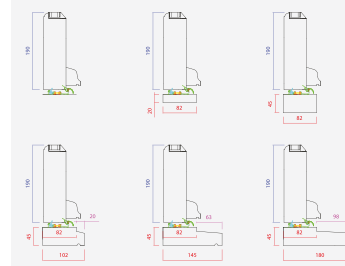

#### Outward door

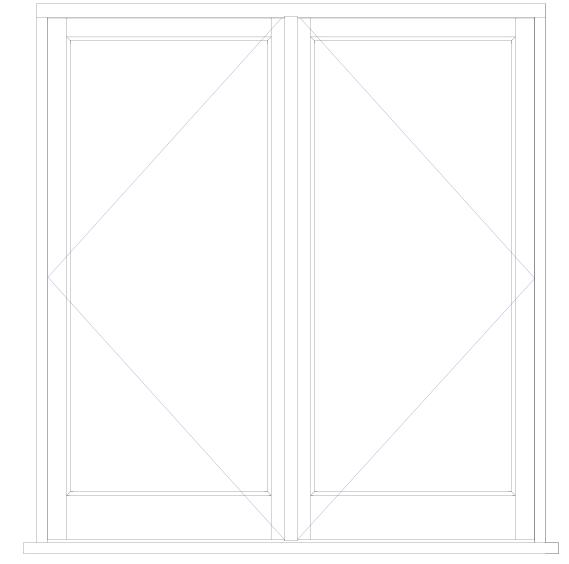
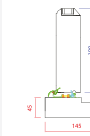
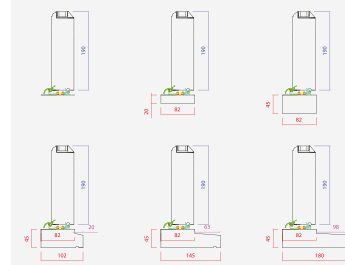

## Triple glazed

### Cill:

### Trickle vent:

#### Inward door

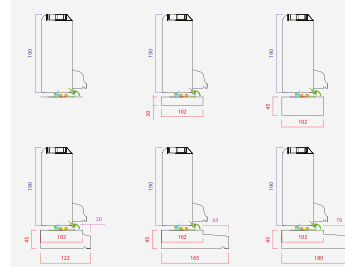

#### Outward door

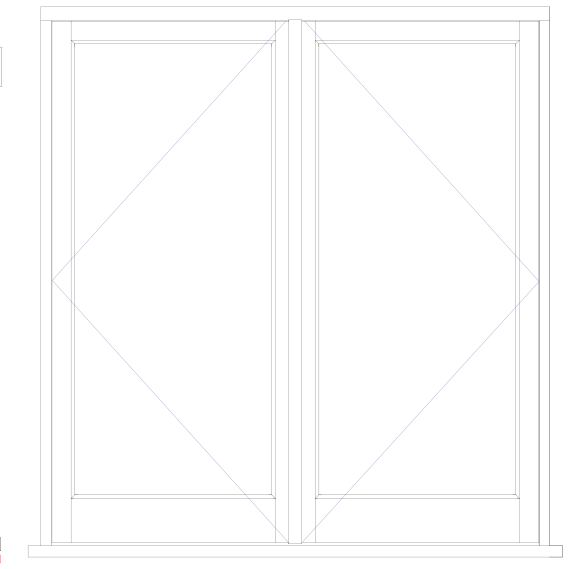
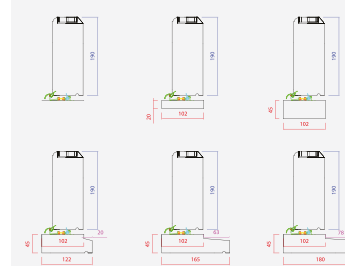

# Sliding door

**1.2**  
W/km<sup>2</sup>K

Double Glazed  
U-Value

**0.69**  
W/km<sup>2</sup>K

Triple Glazed  
U-Value



## About:

Our high security sliding doors are available in a range of configurations, all operating effortlessly.

Using multi-point locking, Ultion 3\* door cylinders and solid Accoya, our sliding doors are not only beautiful, but also safe and secure from unwanted intruders.

**Fab&Fix**



## Feature:

- Seamless corner joints, using twin mortice and tenon joints on all sash corners
- Flush-fit colour matching trickle vents, made from aluminium
- Three coat factory paint finish, dual colour available
- Vertically factory hung, ensuring perfect positioning and squareness
- Externally beaded for tradition, taped glass for high security
- Available with a large outerframe (20mm bigger) or a 20mm add on supplied separately
- Available in a range of configurations
- Crafted by experts
- 70+ year life expectancy

## Specification:

- Easy glide track, guaranteeing a smooth and effortless operation
- High security multi-point door lock
- Ultion 3\* high security cylinders as standard
- Made from solid Accoya, reliably trusted to not visibly swell, shrink or distort
- Choice of hardware finishes
- 1.2 whole door U value with double glazing
- 0.69 whole door U value with triple glazing

## Double glazed

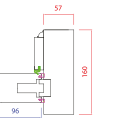
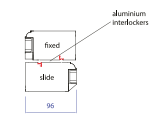
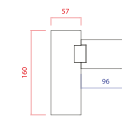
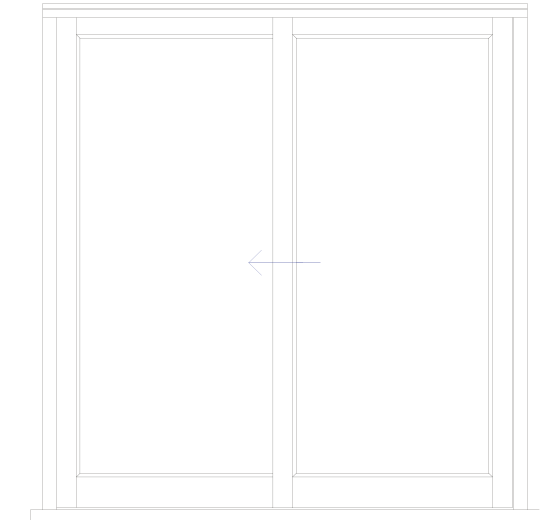
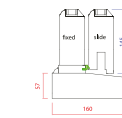
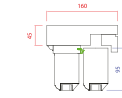
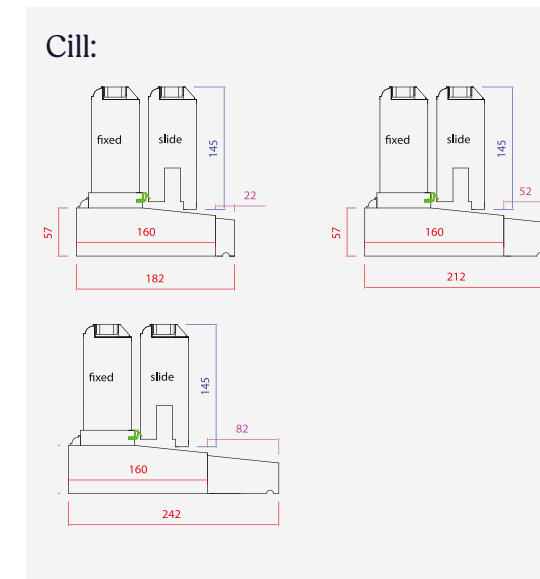

## Triple glazed

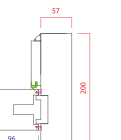
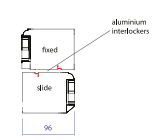
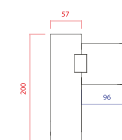
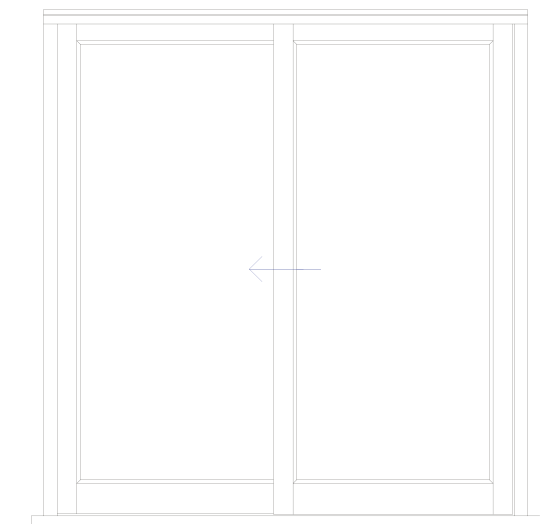
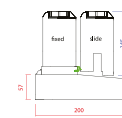
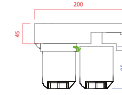
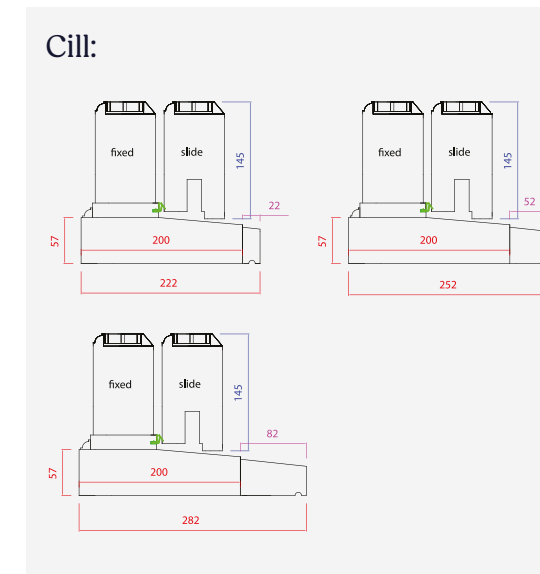



# Bi-folding door

**1.2**  
W/km<sup>2</sup>K

Double Glazed  
U-Value

**0.74**  
W/km<sup>2</sup>K

Triple Glazed  
U-Value



## About:

Our high security bi-folding doors are available in a range of configurations, all operating effortlessly. Using Maco multipoint door locks, Ultion 3\* door cylinders and solid Accoya, our Bi-folding doors are not only beautiful, but also safe and secure from unwanted intruders.



## Feature:

- Seamless corner joints, using twin mortice and tenon joints on all sash corners
- Flush-fit colour matching trickle vents, made from aluminium
- Three coat factory paint finish, dual colour available
- Vertically factory hung, ensuring perfect positioning and squareness
- Externally beaded for tradition, taped glass for high security
- Available with a large outerframe (20mm bigger) or a 20mm add on supplied separately
- Available in a range of configurations
- Crafted by experts
- 70+ year life expectancy

## Specification:

- Maco high security multi-point door lock
- Ultion 3\* high security cylinders as standard
- Made from solid Accoya, reliably trusted to not visibly swell, shrink or distort
- Choice of 7 hardware styles, from 2 suppliers, in multiple finishes
- 1.2 whole door U value with double glazing
- 0.69 whole door U value with triple glazing

## Double glazed

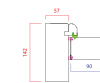
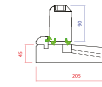
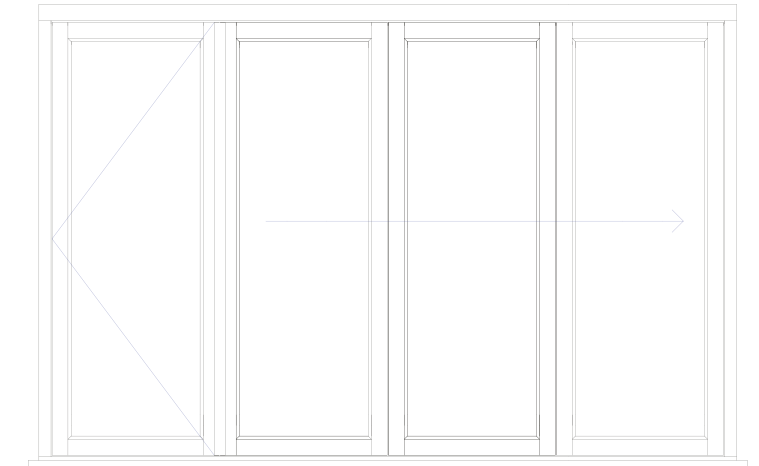
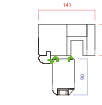
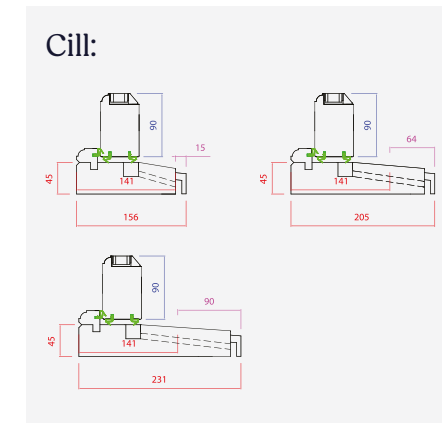

## Triple glazed

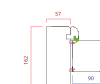
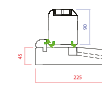
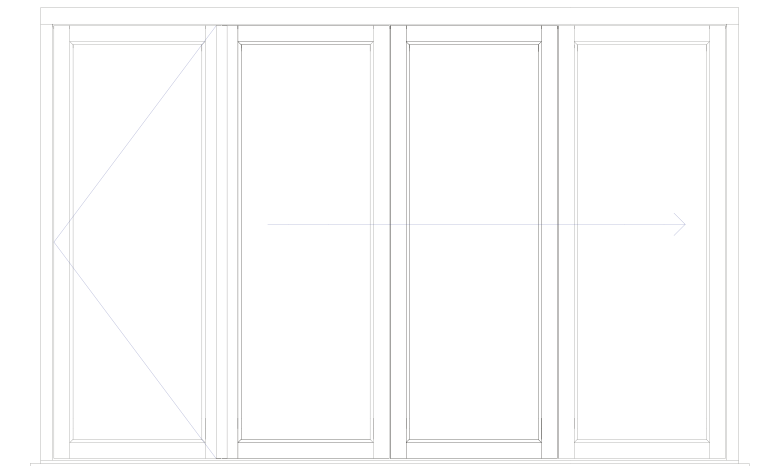
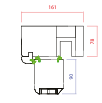
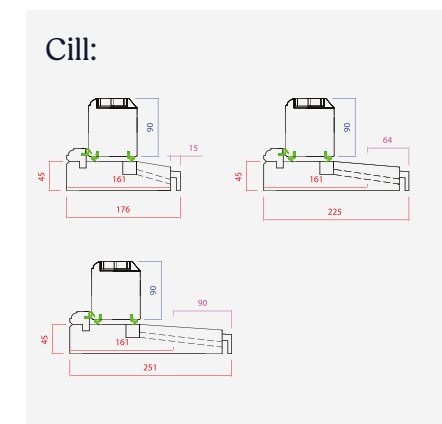

# Colours



Our paint comes from leading supplier Teknos, who have been producing it since 1948.

Teknos have been working in collaboration with Accoya since 2008, making it the perfect combination for a long-lasting finish.

All our windows and doors receive a three-coat professional spray finish before leaving our workshop. We can match any RAL or Farrow & Ball colour, and we can dual-colour, giving a different appearance inside and outside.

Opposite are some of our most popular colours:



Traffic White 9016	Signal White 9003	Pure White 9010	Cream 9001	Wheat Flower White 080 85 05
Soft Greige 060 80 10	Vanilla Cream 060 90 10	Light Apricot 010 90 10	Sunrose Yellow 090 90 60	Cold Pink 350 70 10
Peanut Butter 060 70 20	Reed Green 6013	Sand Grey 095 70 10	Agate Grey 7038	Silk Grey 7044
Pebble Grey 7032	Laurel Grey 120 70 05	Filigree Grey 120 70 20	Soap Grey 130 70 20	Matte Green Sage 130 60 10
Sage Green Grey 150 50 10	North Cape Grey 200 60 10	Grey Mouse 7005	Blackthorn Blue 240 40 10	Galenite Blue 230 30 10
Slate Grey 7015	Graphite Grey 7024	Anthracite Grey 7016	Graphite Black 9011	Jet Black 9005



# Hardware

8 ranges from 2 suppliers

From the  
**Anvil**<sup>®</sup>

From Llandrindod Wells, Wales 'From The Anvil' boast over twenty three years of experience.











Combining beauty with durability, expert Blacksmiths hand craft exquisite products by forging mild steel and hot forging brass to make one-of-a-kind ironmongery that will last a lifetime. This is our super premium grade hardware.











  
**COASTAL**

Born on the rugged shores of Cornwall back in 2003, Coastal Group is a family owned business that specialises in the design and manufacture of precision-made hardware solutions for external doors and windows.



















# Hardware









 COASTAL	Shootbolt window handles				Peg stay & butt hinge window stays, fasteners & hinges				
	Opera shootbolt handle	Regent shootbolt handle	Mitre shootbolt handle	Kuhlen shootbolt handle	Spoon and fastener	Spoon and stay	Mitre fastener	Mitre stay	Window butt hinge
									
Black	✓	✓	✓	✓					✓
Polished brass		✓		✓	✓	✓			✓
Polished stainless brass	✓	✓	✓						✓
Polished stainless steel		✓		✓					✓
Satin stainless steel	✓	✓	✓	✓			✓	✓	✓
Polished chrome					✓	✓			
Satin chrome					✓	✓			

 From the Anvil	Shootbolt window handles			Peg stay & butt hinge window stays, fasteners & hinges						
	Brompton shootbolt handle	Newbury shootbolt handle	Monkeytail shootbolt handle	Monkeytail fastener	Monkeytail stay	Newbury fastener	Newbury stay	Brompton fastener	Brompton stay	Window built hinge
										
Aged brass	✓	✓				✓	✓	✓	✓	✓
Matt black	✓	✓				✓	✓	✓	✓	✓
Satin brass	✓	✓								
Polished chrome	✓	✓				✓	✓	✓	✓	✓
Polished brass	✓	✓				✓	✓	✓	✓	✓
Polished nickel	✓	✓				✓	✓	✓	✓	✓
Aged bronze	✓	✓				✓	✓	✓	✓	✓
Black			✓	✓	✓					
Pewter			✓	✓	✓					

# Matrix

Standard hardware

Sash window hardware						Door handles				Door hardware					
Sash claw fastener	Sash life	Sash ring	Sash stop	Sash pulley	Sash pulley plate	Opera door handle	Regent door handle	Mitre door handle	Kuhlen door handle	Letter box	Door knob	Ring door knocker	Doctor door knocker	Escutcheon	Door butt hinge
															
							✓	✓	✓	✓	✓	✓	✓	✓	✓
✓	✓	✓	✓	✓	✓		✓		✓	✓	✓	✓	✓	✓	✓
						✓	✓	✓		✓	✓	✓	✓	✓	✓
							✓	✓	✓	✓	✓	✓	✓	✓	✓
✓	✓	✓	✓	✓	✓	✓	✓	✓	✓	✓	✓	✓	✓	✓	✓
✓	✓	✓	✓	✓	✓										

Door handles			Door hardware							
Brompton door handle	Newbury door handle	Monkeytail door handle	Letterbox	Back to back pull	Door butt hinge	Brompton door knob	Art decor door knob	Brompton door knocker	Art decor door knocker	Doctor door knocker
										
✓	✓		✓	✓	✓	✓	✓	✓	✓	✓
✓	✓		✓	✓	✓	✓	✓	✓	✓	✓
✓	✓		✓	✓	✓	✓	✓	✓	✓	✓
✓	✓		✓	✓	✓	✓	✓	✓	✓	✓
✓	✓		✓	✓	✓	✓	✓	✓	✓	✓
✓	✓		✓	✓	✓	✓	✓	✓	✓	✓
		✓	✓	✓	✓	✓	✓	✓	✓	✓
		✓	✓	✓	✓	✓	✓	✓	✓	✓



# Finishes



Aged brass      Matt black      Satin brass      Polished chrome      Polished brass



Polished nickel      Aged bronze      Black      Pewter

# Brompton

- Flush and stormproof shootbolt windows
- Flush and stormproof peg and stay windows
- Entrance, French and Bi-folding doors

Illustrated in Aged brass

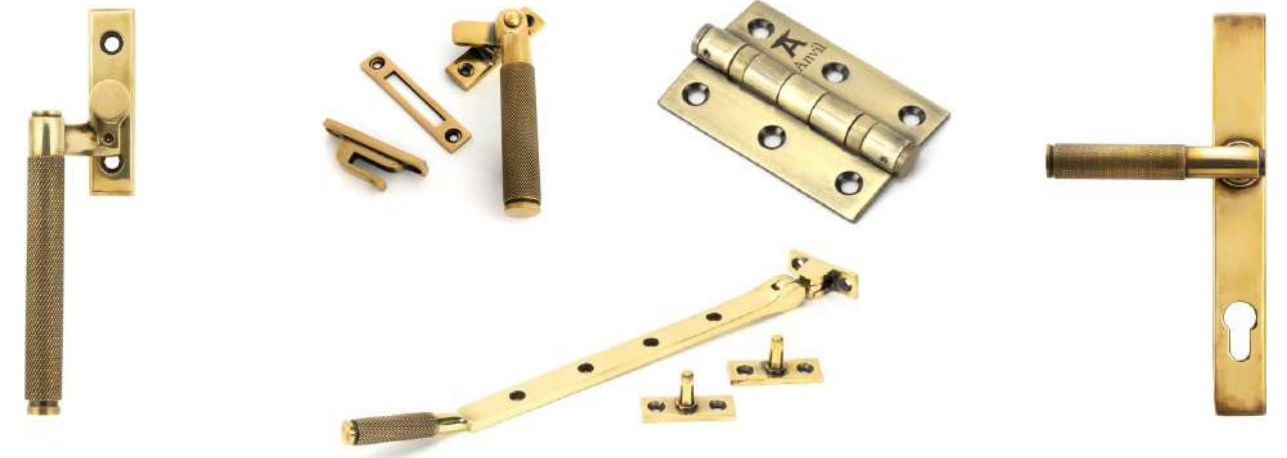

Shootbolt handle      Peg stay, fastener and butt hinge      Door handle



Letterbox      Door hinge      Door pull



Doorknob      Brompton knocker      Art decor knocker      Doctor knocker

- ✿ Flush and stormproof shootbolt windows
- ✿ Flush and stormproof peg and stay windows
- ✿ Entrance, French and Bi-folding doors

Illustrated in polished chrome



Shootbolt handle



Peg stay, fastener and butt hinge



Door handle



Letterbox



Door hinge



Door pull



Doorknob



Art decor knocker



Doctor knocker

- ✿ Flush and stormproof shootbolt windows
- ✿ Flush and stormproof peg and stay windows
- ✿ Entrance, French and Bi-folding doors

Illustrated in black



Shootbolt handle



Peg stay, fastener and butt hinge



Door handle



Letterbox



Door hinge



Door pull



Doorknob



Art decor knocker



Doctor knocker



# Finishes



Satin stainless steel



Polished stainless steel



Satin brass stainless PVD



Polished brass stainless PVD



Black stainless PVD

# Regent



- Flush and stormproof shootbolt windows
- Flush and stormproof peg and stay windows
- Entrance, French and Bi-folding doors

Illustrated in polished stainless steel



Shootbolt handle



Peg stay, fastener and butt hinge



Door handle



Letterbox



Door hinge



Escutcheon



Doorknob



Ring knocker



Doctor knocker

# Opera



- Flush and stormproof shootbolt windows
- Entrance, French and Bi-folding doors

Illustrated in polished stainless brass



Shootbolt handle



Door handle



Letterbox



Door hinge



Escutcheon



Doorknob



Ring knocker



Doctor knocker

# Mitre



- Flush and stormproof shootbolt windows
- Flush and stormproof peg and stay windows
- Entrance, French and Bi-folding doors

Illustrated in satin stainless steel



Shootbolt handle



Peg stay, fastener and butt hinge



Door handle



Letterbox



Door hinge



Escutcheon



Doorknob



Ring knocker



Doctor knocker



- Flush and stormproof shootbolt windows
- Entrance, French and Bi-folding doors

## Door handle



## Window handle



- Spiral balance and lead weight sash windows

## Sash claw fastener



Sash hardware is available in chrome, gold and satin silver



Sash stop



Sash ring



Sash life



Sash pulley



Sash pulley plate



Sash cord



Sash lead weight

# Modern



Entrance doors



Satin stainless steel



Matt black



1800mm



1500mm



1200mm

# Sliding door handle



Sliding doors



White



Premium satin



Graphite



Chrome



Gold



Antique black



Black



# Peace of mind guarantee

For four decades we've perfected the raw materials we buy and the joinery techniques we use to allow us to confidently offer 'peace of mind' guarantees to be proud of.

All guarantees shown below are for timber windows and doors made using Accoya, in accordance with our maintenance guidelines.

## Fungal and Insect



## Workmanship



## Glass Unit



## Hardware



## Paint



## Stain



All guarantees are given in accordance with our guarantee T&C's available on the downloads section of our website.





# Tailored products

---

Whilst our Signature range covers most scenarios and accounts for around 80% of the frames we sell, we can also craft completely bespoke timber windows and doors, tailor made to exact requirements.

---

## Within our Tailored range, we can supply windows and doors that are:

- Made from a range of hardwoods in addition to Accoya
- Available with a stained finish, as well as a paint finish
- Arched, angled and shaped
- Ideal for conservation areas, where the exact shape and size of the frame and sash need to be matched
- Fitted with slimline windows, which are also popular in conservation areas -and sometimes essential to meet Conservation Officer's requirements
- Finished with bespoke hardware that the homeowner or architect has specified

---

For bespoke projects, our expert team are able to guide our customers through every step, providing detailed CAD drawings and technical support.





# Help to sell and grow

We help our trade customers to win orders. It's a competitive market, so we've designed a suite of physical and digital sales tools that help our trade customers to sell more jobs.

As well as custom support, below are some of the tools that help our customers to display, promote and sell our hand-crafted windows and doors.



## Inspirations brochure

**Quantity:** pack of 10  
**Price:** £20 + VAT  
(discount available)

Premium quality 36-page printed brochure, designed to help homeowners fall in love with our windows and doors.

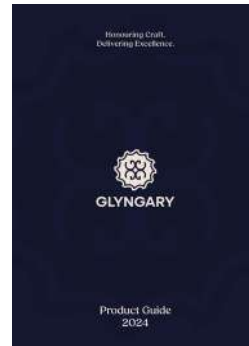

## Product guide

**Quantity:** pack of 10  
**Price:** £20 + VAT  
(discount available)

Premium quality 64-page printed brochure packed with technical information about us and our products, for people in the trade.



## Small sample frame

**Quantity:** 1  
**Price:** £300 + VAT  
(discount available)

Small Accoya sample frame, the perfect size for the boot of a salesperson's car. Available in flush, stormproof or sash.



## Window corner sample

**Quantity:** 1  
**Price:** £100 + VAT  
(discount available)

Accoya window corner sample showing the frame and sash detail, and sealed glass unit. Available in flush, stormproof or sash.



## Large sample frame in movable stand

**Quantity:** 1  
**Price:** £1,000 + VAT  
(discount available)

Large Accoya sample frame pre-installed into a portable display frame, perfect for premium showrooms. Available with flush, stormproof or sash.



## Door corner sample

**Quantity:** 1  
**Price:** £100 + VAT  
(discount available)

Accoya entrance door corner sample showing the door and frame detail, including low threshold.

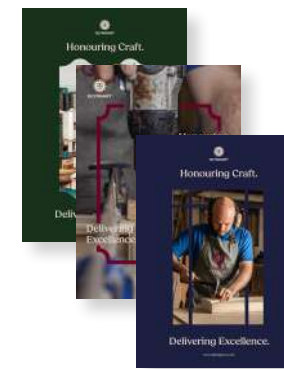

## Printed poster kit (x3)

**Quantity:** pack of 3  
**Price:** £30 + VAT  
(discount available)

3 x printed high-resolution posters showcasing our craft and perfect for framing in showrooms.



## Printed postcard

**Quantity:** pack of 100  
**Price:** £20 + VAT  
(discount available)

A5 postcards showcasing our products and craft. Perfect for letterboxes and handouts. Available printed with your brand and contact details.



## Digital assets pack

**Quantity:** 1  
**Price:** £0

Access to all our digital assets, including photography, videography, logos and artwork.



## Roller banner

**Quantity:** 1  
**Price:** £40 + VAT  
(discount available)

Printed high-resolution roller banner showcasing our craft and perfect for showrooms and exhibitions. Available in 3 designs.



## Trade exhibition day at your premises

**Quantity:** 1  
**Price:** £0

A trade exhibition day held at your premises allowing our National Sales Manager to introduce our product range and its benefits to your trade customers.



## Professional site photoshoot

**Quantity:** 1  
**Price:** £500 + VAT  
(discount available)

A professional site photoshoot of your beautiful installation, done by one of our partnered specialist photographers.



# Contact us:

---

## Website:

[www.glyngary.co.uk](http://www.glyngary.co.uk)

## Email:

[sales@glyngary.co.uk](mailto:sales@glyngary.co.uk)

## Telephone:

01925 763 836

## Socials:



## Address:

Unit E,  
Taylor Business Park  
Risley  
Warrington  
Cheshire  
WA3 6BL

# Honouring Craft.



# Delivering Excellence.





**GLYNGARY**

Unit E,  
Taylor Business Park  
Risley  
Warrington  
Cheshire  
WA3 6BL

Email: [sales@glyngary.co.uk](mailto:sales@glyngary.co.uk)  
Tel: 01925 763 836